



**ASSA ABLOY**  
Opening Solutions

Experience a safer  
and more open world

# Aperio<sup>®</sup> Technology



*Wireless possibilities* for  
online access control





# *Aperio* (Latin) / a'pe.ri.o / to uncover, open

## ELECTRONIC SECURITY HARDWARE

HES | Securitron

---

### *HES K100 Cabinet Lock*

For use with swinging  
and sliding cabinet  
doors and drawers

### *HES KS100 Server Cabinet Lock*

For use with cam-  
activated swing handle  
server cabinet doors

### *Securitron R100 Card Reader*

For use on glass, stone  
or metal surfaces

## ADAMS RITE

---

### *A100 Narrow Stile Electronic Trim*

For use with aluminum  
storefront entrances

### *G100 Digital Glass Door Deadlock*

For use with single or  
double door all-glass  
entrances

## CORBIN RUSSWIN

---

### *IN100 Lock*

For use in commercial and  
institutional applications

## SARGENT

---

### *IN100 and PR100 Locks*

For use in commercial and  
institutional applications

*Designed for easy integration into existing access control systems, the wide range of Aperio-enabled devices allows facilities to add access control to more applications than ever before.*



# An *innovative* new approach to online access control

Aperio® technology is a global wireless platform that reduces the cost and inconvenience of traditional access control, with the flexibility to address any application.

Aperio utilizes local wireless communication between the lock and a communications hub to connect to an electronic access control system. You can easily expand the reach of existing access control systems and secure openings that would otherwise go unprotected.

With the global range of Aperio-enabled locks from ASSA ABLOY, online access control can be easy and cost-effective at any opening, with standardization across locations worldwide.

## ADVANCED CAPABILITIES

- No complex site surveys
- Minimal field configuration
- Simplified installation at the opening
- Fully-encrypted AES 128 wireless communication (IEEE 802.15.4)
- Real-time authentication and alarms

Easily *expand* the reach of your existing access control system

- Wired Access Control Door
- Aperio-Enabled Door

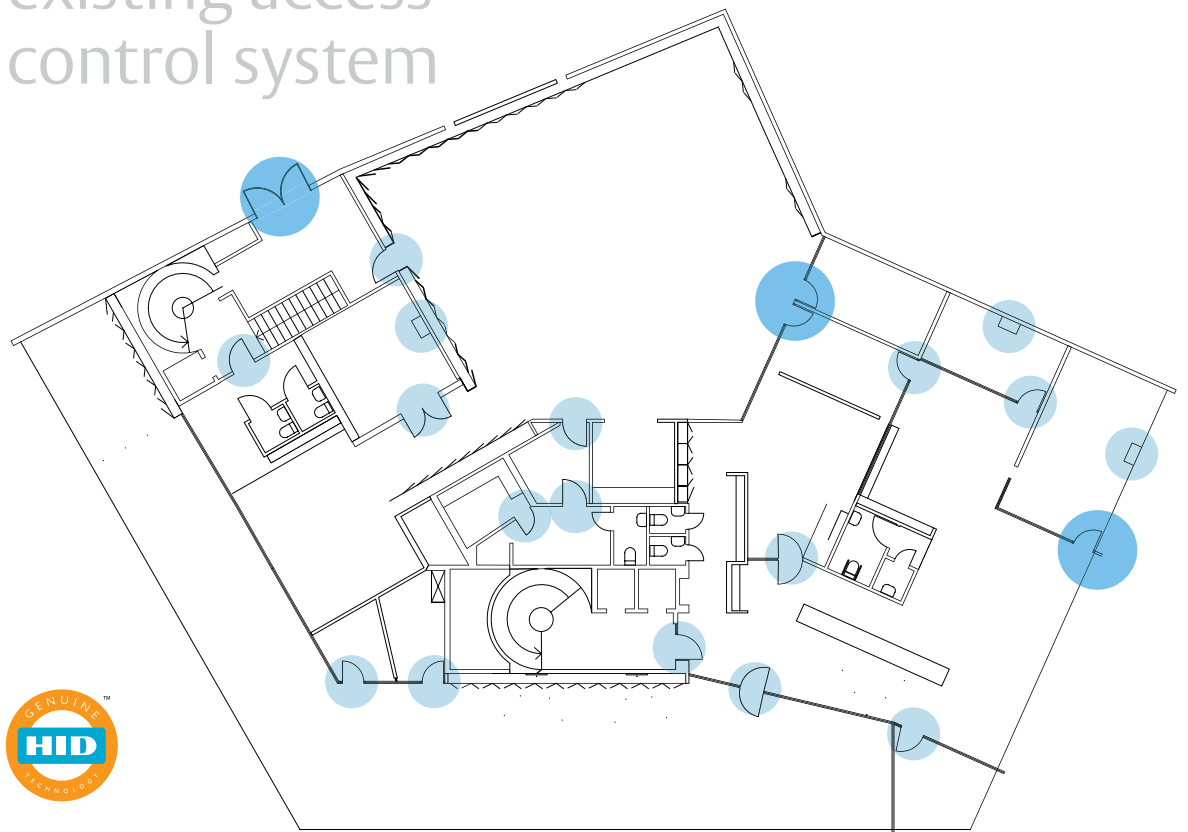



# Aperio® at a Glance

## DEVICES

### SUPPORTED CREDENTIALS

### DEVICE TYPE

### MONITORING

| Brand          | Product Name | Typical Applications   | SUPPORTED CREDENTIALS |                  |                     |               | DEVICE TYPE                               |                   |          |         |             |             |              | MONITORING  |                                       |                         |                       |        |                 |       |                |
|----------------|--------------|--|-----------------------|------------------|---------------------|---------------|---|-------------------|----------|---------|-------------|-------------|--------------|-------------|---------------------------------------|-------------------------|-----------------------|--------|-----------------|-------|----------------|
|                |              |  | 125 kHz Prox          | 13.56 MHz iCLASS | 13.56 MHz iCLASS SE | multiCLASS SE | Dual Factor Keypad (1-16 digit, pin code) | Narrow Stile Trim | Deadlock | Mortise | Cylindrical | Exit Device | Cabinet Lock | Card Reader | Integrated DPS (Door Position Switch) | Locked State Monitoring | REX (Request to Exit) | Tamper | Battery Voltage | Other |                |
| ADAMS RITE     | A100         | Narrow stile aluminum storefront entrances   | •                     | •                |                     |               | •   | •                 |          |         |             |             |              |             |                                       |                         | • †                   |        | •               | •     |                |
|                | G100         | All-glass single or double doors with a fixed leaf                                   |                       |                  | •                   |               |   |                   | •        |         |             |             |              |             |                                       |                         |                       | •      |                 | •     |                |
| CORBIN RUSSWIN | IN100        | Commercial openings (offices, conference rooms, budget sensitive customers); schools |                       |                  |                     | •             |   |                   | •        | •       | •           |             |              |             |                                       |                         | •                     |        | •               | •     |                |
| HES            | K100         | Swinging and sliding cabinet doors and drawers with up to 2-1/4" thickness           |                       |                  |                     | •             |   |                   |          |         |             | •           |              |             |                                       |                         | •                     |        | •               | •     | Lock jamb      |
|                | KS100        | Cam-activated swing handle server cabinet doors with a 150 x 25 mm lock prep         |                       |                  |                     | •             |   |                   |          |         |             | •           |              |             |                                       |                         | • †                   | •      | •               | •     | Cam activation |
| SARGENT        | IN100        | Commercial openings (offices, conference rooms, budget sensitive customers); schools |                       |                  |                     | •             |   |                   | •        | •       | •           |             |              |             |                                       |                         | •                     |        | •               | •     |                |
|                | PR100        | Institutional openings (schools, hospitals)  | •                     | •                |                     |               | •   |                   |          | •       | •           | •           |              |             |                                       |                         | •                     |        | •               | •     | Dead bolt      |
| SECURITRON     | R100         | Glass, stone or metal surfaces   |                       |                  |                     | •             |   |                   |          |         |             |             |              |             |                                       |                         | •                     |        | •               | •     |                |

† Optional accessory purchased separately



A photograph of a modern, multi-level atrium. The space is characterized by its clean, white architectural lines and large glass windows. In the foreground, a highly reflective, polished floor mirrors the surrounding environment, including the glass entrance and the sky. The entrance consists of a set of glass doors with a curved glass canopy above them. To the right, a wooden bench is positioned near a wall with a large potted plant. The overall atmosphere is bright and airy, with natural light streaming in from the windows.

Wireless *possibilities* for  
online access control





# Quick, easy *wireless* deployments

## G100 DIGITAL GLASS DOOR DEADLOCK

*Fashion-forward design that  
harmonizes style and security*

The sophisticated styling of the Adams Rite G100 lends itself to beautiful all-glass doors in ways no other lock can. Compared to traditional options such as electromagnetic locks or cutting and drilling patch fittings, the G100 offers superior styling and convenience with the added security of dual-factor authentication and fully encrypted wireless communication to the host access control system.





# R100 CARD READER

*Retrofit access control for glass, metal or stone surfaces*

The Securitron R100 surface mounted wireless card reader offers a cost-effective, aesthetically pleasing way to extend access control to glass, metal or stone surfaces without the need for cutting or drilling. It provides flexible, robust retrofit options for entryways unlike any the industry has seen before.



## FEATURES & BENEFITS

|                            | G100  | R100  |
|----------------------------|---|---|
| <b>Works With:</b>         | Swinging single or double all-glass door applications with a fixed leaf 7/16" to 1/2" (11.1 mm to 12.7 mm) glass door thickness   | Most smooth glass, metal or stone surfaces without the need of additional third party adhesives   |
| <b>Installation:</b>       | Surface mounted trim, no cutting or drilling required   | Surface mounted, no drilling required for easy installation   |
| <b>Special Features:</b>   | Real time REX, DPS, tamper and battery health monitoring  | Real time tamper and battery health monitoring  |
| <b>Design:</b>             | Non-handed with Lever knob  | Tamper and weather resistant protected by integrated monitoring   |
| <b>Key Override:</b>       | N/A   | N/A   |
| <b>Options:</b>            | N/A   | Adhesive aluminum dress cover plate (R100-DPK)  |
| <b>Credential Support:</b> | <b>High Frequency (13.56 MHz):</b> HID iCLASS®, HID iCLASS SE® (SIO-enabled), HID iCLASS® Seos®, HID MIFARE® SE, HID DESFire® EV1 SE, MIFARE Classic, MIFARE DESFire EV1, NFC-enabled mobile phones | Supports HID multiCLASS SE® card technologies<br><b>High Frequency (13.56 MHz):</b> HID iCLASS®, HID iCLASS SE® (SIO-enabled), HID iCLASS® Seos®, HID MIFARE® SE, HID DESFire® EV1 SE, MIFARE Classic, MIFARE DESFire EV1, NFC-enabled mobile phones<br><b>Low Frequency (125 kHz):</b> HID Prox®, Kantech ioProx, AWID, EM4102 |





*Access control* in a flash



# A100

## NARROW STILE TRIM

### *Electronic access control trim for aluminum storefront entrances*

The Adams Rite A100 provides safety, security and convenience at a cost-effective price for retrofitting aluminum and hollow metal entrances with electronic access control. Ideal for both interior and exterior door applications, the A100 offers an easy-to-install electronic access control trim for openings with existing Adams Rite deadlocks, deadlatches and exit devices.



## FEATURES & BENEFITS

### A100

|                            |   |
|----------------------------|---|
| <b>Works With:</b>         | Adams Rite MS <sup>®</sup> Series Deadlocks, 4500/4900 Series Deadlatches, and 8000 Series Exit Devices; Yale 7200 Series and Corbin Russwin ED4000 Series Rim Exit Devices                     |
| <b>Installation:</b>       | Surface mounted with concealed fasteners for 1-3/4" to 2-1/4" [44.5 mm to 57.2 mm] door thickness   |
| <b>Special Features:</b>   | Field-selectable handing using clutched-protected lever   |
| <b>Design:</b>             | Surface-mounted trim with concealed fasteners for use on swinging narrow stile aluminum doors from 1-3/4" to 2-1/4" [44.5 mm to 57.2 mm] door thickness   |
| <b>Key Override:</b>       | 5-pin mortise cylinder  |
| <b>Options:</b>            | Dual-factor authentication when using keypad (1-16 digit pin codes); Request to Exit and Door Position Switch (sold separately)   |
| <b>Credential Support:</b> | <ul style="list-style-type: none"><li>• <b>High Frequency (13.56 MHz):</b> HID 13.56 MHz iCLASS<sup>®</sup> (ISO 15693)</li><li>• <b>Low Frequency (25 kHz):</b> HID Prox<sup>®</sup></li></ul> |

# Refining wireless access control



K100

CABINET LOCK

*Add security and accountability to cabinets, lockers and drawers*

The HES K100 wireless cabinet lock with Aperio® technology expands access control to lockers, drawers or cabinet doors. Control and track access to pharmaceuticals, prototypes, restricted documents, evidence, tools and high value materials through the use of existing ID badges.



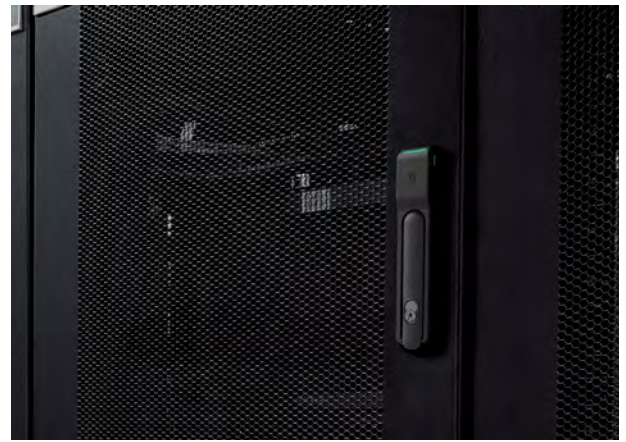

## KS100 SERVER CABINET LOCK

*Protect sensitive data and equipment against malicious attacks or tampering while ensuring compliance*

The HES KS100 provides rack level security for data centers and emergency operations centers looking to bring real-time monitoring and managed access to server cabinet doors. It is available standard with locked state monitoring and utilizes an SFIC (Small Format Interchangeable Core) mechanical key override. For high security applications, an optional extended DPS monitoring sensor can be connected to ensure that the cabinet is closed, locked and secure.



### FEATURES & BENEFITS

|                            | K100  | KS100   |
|----------------------------|---|---|
| <b>Works With:</b>         | Swinging or sliding cabinet doors and drawers up to 2-1/4" thickness  | For use with cam-activated swing handle server cabinet applications with a 150 x 25 mm lock prep  |
| <b>Installation:</b>       | Surface mounted lock and trim with concealed fasteners  | No-cutting required when installed in an existing 150 x 25 mm lock prep.  |
| <b>Special Features:</b>   | Real time DPS (locked state), tamper and battery health monitoring  | Real time integrated locked state (handle), cam rotation, tamper and battery health monitoring  |
| <b>Design:</b>             | Weather resistant non-handed with Pinch or Lever knob options and 3 shaft lengths to accommodate up to 2-1/4" door thickness  | Tamper resistant protected by integrated monitoring and SFIC mechanical or intelligent key override   |
| <b>Key Override:</b>       | Optional cam activated cylinder (sold separately)   | Optional 6 or 7-pin SFIC (sold separately)  |
| <b>Options:</b>            | Open back strike plate (OBS-622) for drawer applications  | External Door Status Monitoring (KS-DPS)  |
| <b>Credential Support:</b> | <ul style="list-style-type: none"> <li><b>High Frequency (13.56 MHz):</b> HID iCLASS®, HID iCLASS SE® (SIO-enabled), HID iCLASS® Seos®, HID MIFARE® SE, HID DESFire® EV1 SE, MIFARE Classic, MIFARE DESFire EV1, NFC-enabled mobile phones</li> <li><b>Low Frequency (25 kHz):</b> HID Prox®, Kantech ioProx, AWID, EM4102</li> </ul> | <ul style="list-style-type: none"> <li><b>High Frequency (13.56 MHz):</b> HID iCLASS®, HID iCLASS SE® (SIO-enabled), HID iCLASS® Seos®, HID MIFARE® SE, HID DESFire® EV1 SE, MIFARE Classic, MIFARE DESFire EV1, NFC-enabled mobile phones</li> <li><b>Low Frequency (25 kHz):</b> HID Prox®, Kantech ioProx, AWID, EM4102</li> </ul> |





A wireless *solution*  
that is truly easy

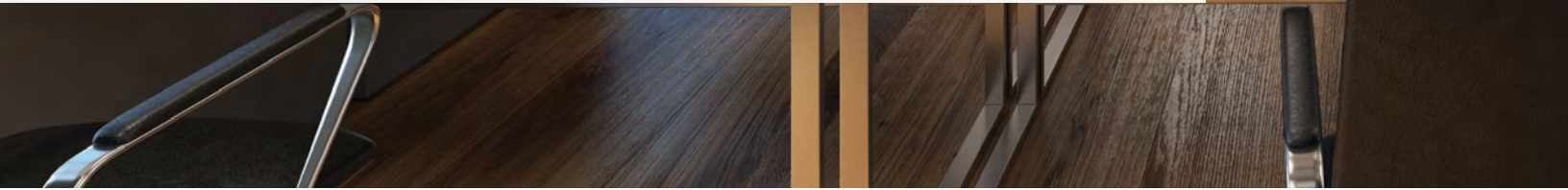

## IN100 LOCK

*Expand your access control system easily and affordably*

Available from ASSA ABLOY Group brands Corbin Russwin and Sargent, the IN100 lock with Aperio® Technology makes access control easy and affordable. This next generation lock offers the convenience and flexibility of Aperio wireless technology with the real-time communication of online access control. As part of the Aperio family of wireless locks, the IN100 offers easy expansion of existing access control systems to bring a new level of control to your facility.





## PR100 LOCK

*Bring access control deeper into your facility*

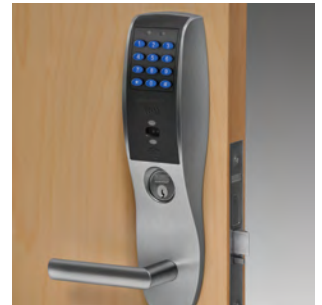

The Sargent PR100 lock with Aperio® Technology makes it easy and cost-effective to bring access control to additional doors. It uses local wireless communication between an Aperio lock and hub to connect to an access control system, eliminating the greatest cost and inconvenience of traditional access control – the wiring at the door.

## FEATURES & BENEFITS

|                            | IN100  | PR100  |
|----------------------------|--|--|
| <b>Hardware:</b>           | ANSI/BHMA Grade 1 hardware for the highest degree of physical security available in access control locks   | ANSI/BHMA Grade 1 hardware for the highest degree of physical security available in access control locks                           |
| <b>Installation:</b>       | Quick and easy — integrated reader, monitoring and short range wireless radio simplifies installation and reduces material costs   | Quick and easy — integrated reader, monitoring and short range wireless radio simplifies installation and reduces material costs   |
| <b>Monitoring:</b>         | Real-time door status monitoring with REX, DPS, tamper and low battery signals   | Real-time door status monitoring with REX, DPS, deadbolt, tamper and low battery signals   |
| <b>Special features::</b>  | <ul style="list-style-type: none"> <li>Lockdown capability allows the IN100 to respond to lock/unlock commands from a host EAC system in less than 10 seconds in battery-powered applications</li> <li>Support for passage mode scheduling offers convenience for office environments</li> </ul>   | N/A  |
| <b>Available in:</b>       | Cylindrical lock, mortise lock, and exit device configurations, offering the flexibility to support a variety of openings  | 10 Line Bored Lock, 8200 Series Mortise Lock, and 80-Series Exit Device, offering the flexibility to support a variety of openings |
| <b>Options:</b>            | Patent-pending credential cache ensures access when the lock is offline from the EAC system  | Available with keypad for two-factor authentication  |
| <b>Credential support:</b> | <ul style="list-style-type: none"> <li><b>13.56 MHz credentials (SE option):</b> HID iCLASS®, iCLASS SE® (SIO-enabled), iCLASS Seos®, SIO® on MIFARE Classic®, SIO® on MIFARE DESFire EV1, MIFARE Classic, DESFire EV1, NFC-enabled mobile phones</li> <li><b>125 kHz credentials (PA option):</b> HID Prox, Kantech ioProx, AWID, EM4102</li> </ul> | Supports HID® 125 kHz Prox or 13.56 MHz iCLASS® contactless credentials  |

# Aperio® Hubs

Designed for easy integration into existing access control systems, Aperio-enabled locks communicate wirelessly to an Aperio hub, which connects to the access control system using Ethernet, RS-485 or Wiegand wiring.

| Order String      | Description                | Max. # Devices Supported by Hubs | Conductors Required | Communication Interface |
|-------------------|----------------------------|----------------------------------|---------------------|-------------------------|
| AH-20-W14-NNNN    | Wiegand Hub                | 1                                | 12                  | Wiegand                 |
| AH-30-R12-NNNN    | Generic RS-485 Hub         | 8                                | 5                   | RS-485                  |
| AH-30-RN1-(XXXX)* | Mercury-Powered RS-485 Hub | 8                                | 5                   | RS-485                  |
| AH-30-R25-NNNN    | VertX® Hub                 | 2                                | 5                   | RS-485                  |
| AH-40-IN2-NNNN    | IP Hub                     | 16                               | Cat 5 or higher     | IP                      |

\* Replace (XXXX) with Mercury Access Control Manufacturer Partner Code

## APERIO® HUB SPECIFICATIONS

| Aperio Hub                      |   |
|---------------------------------|---|
| <b>Wireless Coverage Range:</b> | Up to 50 feet between the Aperio locking device and communication hub on building environments  |
| <b>Voltage:</b>                 | 8 to 24 VDC   |
| <b>IP Hub:</b>                  | Supports PoE, IEEE 802.3af compliant Class 1 powered device (PD)  |
| <b>Maximum Standby Current:</b> | 80 mA at 12 VDC / 250 mA at 24 VDC  |
| <b>Operating Temperature</b>    | 41 to 95° F (5 to 35° C)  |
| <b>Operating Humidity:</b>      | 0 to 95% relative humidity non-condensing   |
| <b>Monitoring:</b>              | AH20 includes 4 form C relays for door status monitoring (DPS, REX, battery, tamper)  |
| <b>Options:</b>                 | An optional external antenna (part no. EXT-10-ANT) with max antenna gain of 3.9 dBi (SMA connector) is available for use with AH20, AH30 and AH40 Aperio hubs. This is a 2.4 GHz dipole, omnidirectional antenna that may be used to obtain a more uniform coverage pattern (in the form of a dough nut) around the hub. Please note that this does not extend the maximum range of the hub and is limited to no more than 25 feet between the locking device and hub (reference illustrations to the right). |

## WIRELESS COVERAGE

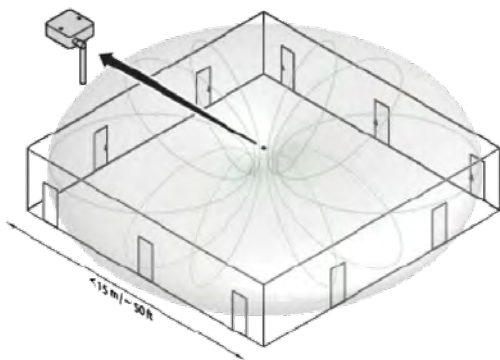

With external antenna

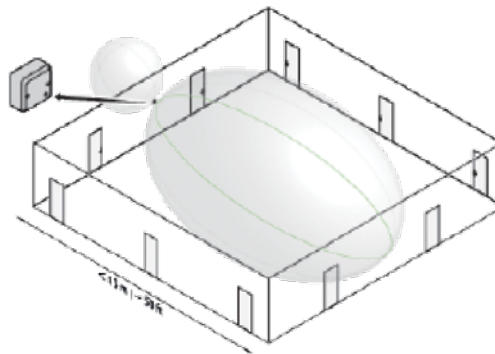

Without external antenna



# IP Hub

(AH40)

The IP Aperio hub uses standard Ethernet cabling to connect to IP-based access control systems and supports up to 16 devices per hub.

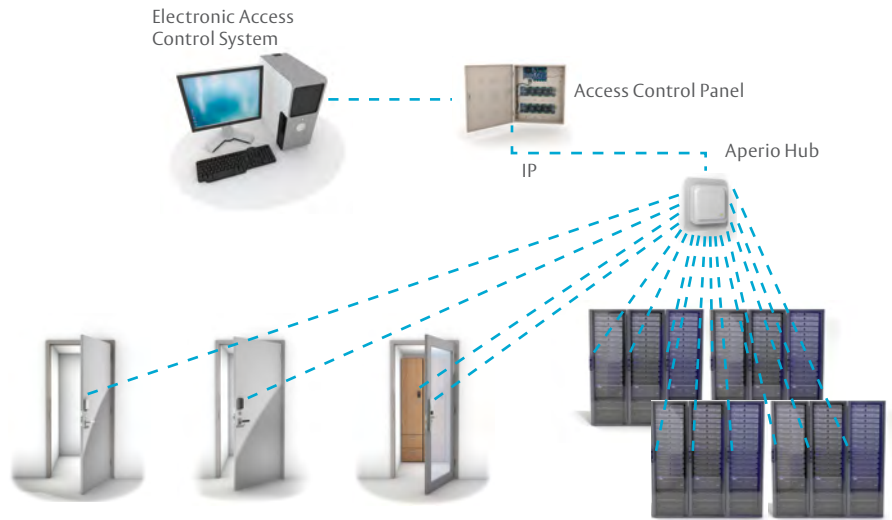

# 1:8 Hub

(AH30-R12/RN1)

The Mercury-Powered and standard RS-485 versions of the Aperio hub offer the flexibility and scalability to support up to eight devices per hub\*.

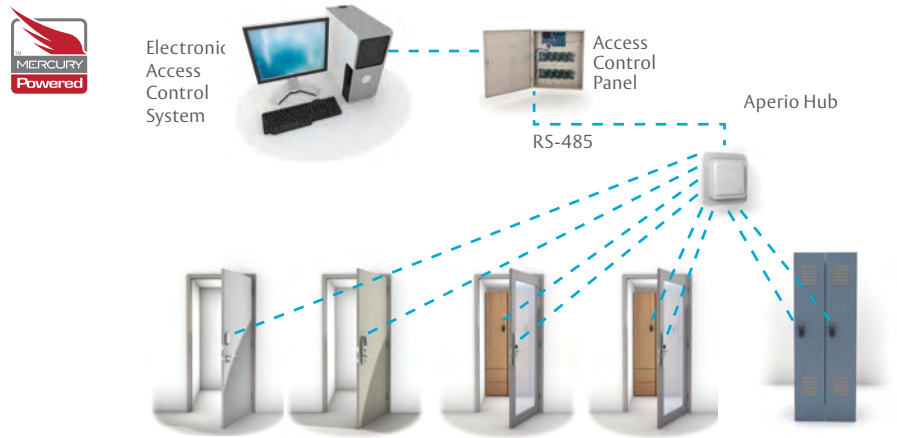

# Wiegand Hub

(AH20)

Industry standard Wiegand output offers easy integration with many popular access control systems.

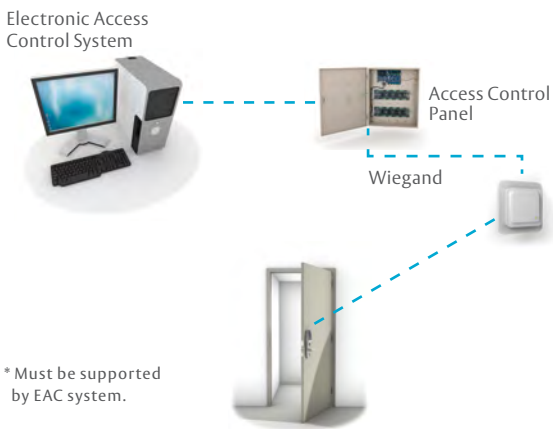

\* Must be supported by EAC system.

# VertX-Powered Hub

(AH30-R25)

The VertX<sup>®</sup>-powered Aperio hub connects to the access control system using RS-485 wiring and supports up to two devices per hub.

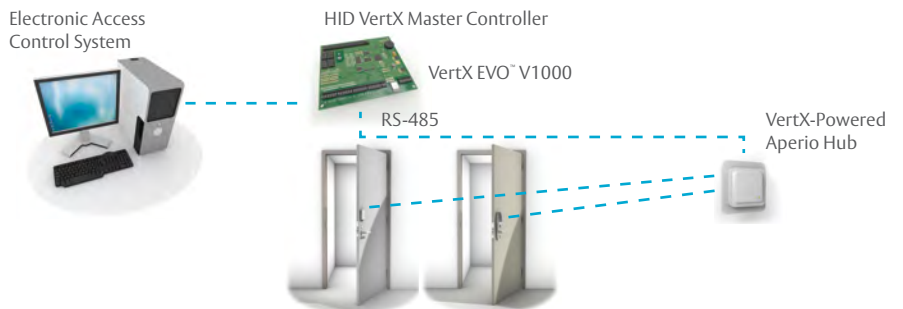



The ASSA ABLOY Group is the global leader in access solutions. Every day, we help billions of people experience a more open world.

ASSA ABLOY Opening Solutions leads the development within door openings and products for access solutions in homes, businesses and institutions. Our offering includes doors, frames, door and window hardware, locks, perimeter fencing, access control and service.

**ASSA ABLOY**  
Opening Solutions

ELECTRONIC SECURITY HARDWARE  
HES | Securitron

ADAMS RITE | CORBIN RUSSWIN | SARGENT

ASSA ABLOY Opening Solutions  
Door Security Solutions  
110 Sargent Drive  
New Haven, CT 06511  
[www.assaabloydss.com](http://www.assaabloydss.com)  
1.800.DSS.EZ4U (377.3948)

ASSA ABLOY Opening Solutions  
Door Security Solutions Canada  
160 Four Valley Drive  
Vaughan, ON L4K 4T9  
[www.assaabloy.ca](http://www.assaabloy.ca)  
800.461.3007

HID, iCLASS and iCLASS SE are registered trademarks of HID® Global Corporation.  
The Mercury Powered trademark is used under express license from Mercury Security Corporation.

Copyright © 2019, ASSA ABLOY Sales and Marketing Group, Inc., an ASSA ABLOY Group company. All rights reserved. Reproduction in whole or in part without the express written permission of ASSA ABLOY Sales and Marketing Group, Inc. is prohibited.

Effective 7/19  
2500-4504